



HSK-MRC コレットチャックホルダ

COLLET CHUCK HOLDER



- ◆ 耐久力、高精度コレットチャック。 High precision collet chuck with durability.
- ◆ シンクロタップ完全対応。 Can be used for Synchro tap.
- ◆ 高バランスボディ 高速回転のボディバランスを最小必要部の研削加工を施して有ります。
Pre-balanced symmetrically for higher R.P.M.
- ◆ オイルホール対応可能。 Coolant through body.

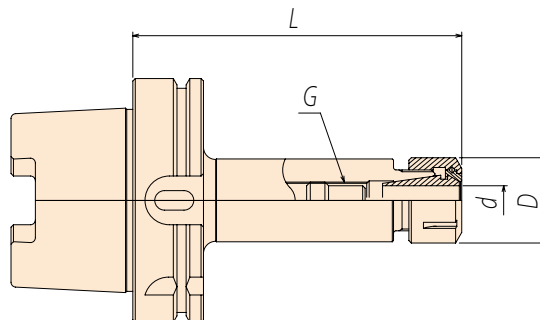

HSK63

CODE		ϕd	L	D	G
A63-MRC10	- 90	0.5 ~ 10.0	90	28	M11 × P1.0
	-120		120		
	-200		200		
A63-MRC13	- 90	1.0 ~ 13.0	90	35	M15 × P1.5
	-120		120		
	-200		200		
A63-MRC16	- 90	1.0 ~ 16.0	90	42	M18 × P1.5
	-120		120		
	-200		200		
A63-MRC20	- 90	2.0 ~ 20.0	90	50	M22 × P1.5
	-120		120		
	-200		200		

HSK100

CODE		ϕd	L	D	G
A100-MRC10	-105	0.5 ~ 10.0	105	28	M11 × P1.0
	-135		135		
	-200		200		
	-300		300		
A100-MRC13	-105	1.0 ~ 13.0	105	35	M15 × P1.5
	-135		135		
	-200		200		
	-300		300		
A100-MRC16	-105	1.0 ~ 16.0	105	42	M18 × P1.5
	-135		135		
	-200		200		
	-300		300		
A100-MRC20	-105	2.0 ~ 20.0	105	50	M22 × P1.5
	-135		135		
	-200		200		
	-300		300		
			350		

■ ナットは付属していますが、コレット、レンチは別途ご注文ください。

普通コレットMRC10~MRC20 P35 タップコレット P37

Comes with collet nut, purchase collet & wrench separately.

■ クーラントパイプは付属されております(固定式)。 Coolant pipe is included.



MRC コレットチャックホルダ

COLLET CHUCK HOLDER



BT50

CODE	FIG	ϕd	L	D	G	C	θ	H
BT50-MRC10	1	0.5 ~ 10.0	150	28	M11 × P1.0	-	-	-
			200					
			250					
	2		300			49.3	10°	200
			350			56.5		230
BT50-MRC13	1	1.0 ~ 13.0	150	35	M15 × P1.5	-	-	-
			200					
			250					
	2		300			56.1	10°	250
			350					
BT50-MRC16	1	1.0 ~ 16.0	150	42	M18 × P1.5	-	-	-
			200					
			250					
			300					
			350					
BT50-MRC20	1	2.0 ~ 20.0	100	50	M22 × P1.5	-	-	-
			150					
			200					
			250					
			300					
350								

■ナットは付属していますが、コレット、レンチは別途ご注文ください。 Comes with collet nut, purchase collet & wrench separately.
 普通コレットMRC10~MRC20 P35 タップコレット P37

レンチ

WRENCH

CODE	L	適用するナット Nut Size
MRS-10	E16P	145 MRC10 - Hi-Q - ERB16
MRS-13	E20P	170 MRC13 - Hi-Q - ERB20
MRS-16	E25	210 MRC16 - Hi-Q - ERB25
MRS-20	E32	250 MRC20 - Hi-Q - ERB32



ナット締付推奨トルク

CODE	NUT	Nm
MRC10	HiQ-ERB16	39
MRC13	HiQ-ERB20	46
MRC16	HiQ-ERB25	78
MRC20	HiQ-ERB32	115

クーラントシール付き調整ネジ

BACK-UP SCREW W/COOLANT SEAL

適合するホルダ

CODE	d	D	L	H	h	Holder Size
MRMC11	M11 P=1.0	9	15	10	2.5	MRC10
MRMC15	M15 P=1.5	12	18	13	3	MRC13
MRMC18	M18 P=1.5	15	19			MRC16
MRMC22	M22 P=1.5	19	19			MRC20

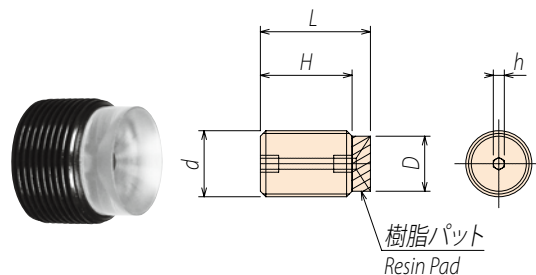

高圧用バックアップスクリュー

BACK-UP SCREW FOR HIGH PRESSURE

CODE	d	D	L	H	h	O-ring
HRMS11	M11P=1.0	8	25	10	2.5	N 4
HRMS15	M15P=1.5	12			3	P 6
HRMS18	M18P=1.5	15	4		P 9	
HRMS22	M22P=1.5	19	5		P 12	

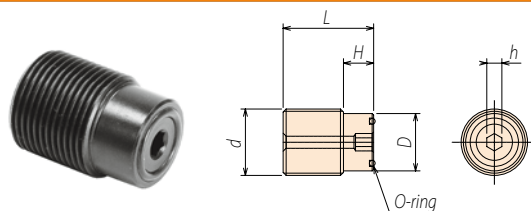



MRC 小径用精密コレット

MICRO PRECISION COLLET



超小径マイクロボアコレット MICRO BORE COLLET



径 mm	MRC5-MB	MRC7-MB
0.2	MRC5-MB02	MRC7-MB02
0.3	MRC5-MB03	MRC7-MB03
0.4	MRC5-MB04	MRC7-MB04
0.5	MRC5-MB05	MRC7-MB05
0.6	MRC5-MB06	MRC7-MB06
0.7	MRC5-MB07	MRC7-MB07
0.8	MRC5-MB08	MRC7-MB08
0.9	MRC5-MB09	MRC7-MB09

■呼び径のみクランプでき、把握範囲はございません。
Only available in nominal diameter. There is no chucking range.

小径コレット SMALL DIA. COLLET

径 mm	MRC5		MRC7	
	普通級 Standard collet	精度級 Precision collet	普通級 Standard collet	精度級 Precision collet
0.5 ~ 1.0	MRC5-1	MRC5-U 1	MRC7-1	MRC7-U 1
1.0 ~ 1.5	MRC5-1.5	MRC5-U 1.5	MRC7-1.5	MRC7-U 1.5
1.5 ~ 2.0	MRC5-2	MRC5-U 2	MRC7-2	MRC7-U 2
2.0 ~ 2.5	MRC5-2.5	MRC5-U 2.5	MRC7-2.5	MRC7-U 2.5
2.5 ~ 3.0	MRC5-3	MRC5-U 3	MRC7-3	MRC7-U 3
3.0 ~ 3.5	MRC5-3.5	MRC5-U 3.5	MRC7-3.5	MRC7-U 3.5
3.5 ~ 4.0	MRC5-4	MRC5-U 4	MRC7-4	MRC7-U 4
4.0 ~ 4.5	MRC5-4.5	MRC5-U 4.5	MRC7-4.5	MRC7-U 4.5
4.5 ~ 5.0	MRC5-5	MRC5-U 5	MRC7-5	MRC7-U 5
5.0 ~ 5.5	-	-	MRC7-5.5	MRC7-U 5.5
5.5 ~ 6.0	-	-	MRC7-6	MRC7-U 6
6.0 ~ 6.5	-	-	MRC7-6.5	MRC7-U 6.5
6.5 ~ 7.0	-	-	MRC7-7	MRC7-U 7

MRC コレット

STANDARD COLLET

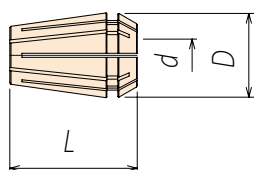

	外径 D	長さ L
MRC10	17	27.5
MRC13	21	31.5
MRC16	26	34
MRC20	33	40

■コレットに角を施したタップ専用コレットもあります。 Also available collet for tapping.

MRC10		MRC13		MRC16		MRC20	
把握範囲 Chucking range 0.5 ~ 10.0mm		把握範囲 Chucking range 1.0 ~ 13.0mm		把握範囲 Chucking range 1.0 ~ 16.0mm		把握範囲 Chucking range 2.0 ~ 20.0mm	
CODE	径 d	CODE	径 d	CODE	径 d	CODE	径 d
MRC10-1	0.5 ~ 1.	MRC13-2	1. ~ 2.	MRC16-2	1. ~ 2.	MRC20-3	2. ~ 3.
MRC10-2	1. ~ 2.	MRC13-3	2. ~ 3.	MRC16-3	2. ~ 3.	MRC20-4	3. ~ 4.
MRC10-3	2. ~ 3.	MRC13-4	3. ~ 4.	MRC16-4	3. ~ 4.	MRC20-5	4. ~ 5.
MRC10-4	3. ~ 4.	MRC13-5	4. ~ 5.	MRC16-5	4. ~ 5.	MRC20-6	5. ~ 6.
MRC10-5	4. ~ 5.	MRC13-6	5. ~ 6.	MRC16-6	5. ~ 6.	MRC20-7	6. ~ 7.
MRC10-6	5. ~ 6.	MRC13-7	6. ~ 7.	MRC16-7	6. ~ 7.	MRC20-8	7. ~ 8.
MRC10-7	6. ~ 7.	MRC13-8	7. ~ 8.	MRC16-8	7. ~ 8.	MRC20-9	8. ~ 9.
MRC10-8	7. ~ 8.	MRC13-9	8. ~ 9.	MRC16-9	8. ~ 9.	MRC20-10	9. ~ 10.
MRC10-9	8. ~ 9.	MRC13-10	9. ~ 10.	MRC16-10	9. ~ 10.	MRC20-11	10. ~ 11.
MRC10-10	9. ~ 10.	MRC13-11	10. ~ 11.	MRC16-11	10. ~ 11.	MRC20-12	11. ~ 12.
		MRC13-12	11. ~ 12.	MRC16-12	11. ~ 12.	MRC20-13	12. ~ 13.
		MRC13-13	12. ~ 13.	MRC16-13	12. ~ 13.	MRC20-14	13. ~ 14.
				MRC16-14	13. ~ 14.	MRC20-15	14. ~ 15.
				MRC16-15	14. ~ 15.	MRC20-16	15. ~ 16.
				MRC16-16	15. ~ 16.	MRC20-17	16. ~ 17.
						MRC20-18	17. ~ 18.
						MRC20-19	18. ~ 19.
						MRC20-20	19. ~ 20.

MRC 小径用精密コレット MICRO PRECISION COLLET



MRC タップコレット

STANDARD TAP COLLET



- ◆ コレット内径に角穴を施したタップ滑りに強いタップ専用コレット高精度タッピング加工に最適。

Special designed collets for high accurate tapping with special square bore in collet I.D. to avoid slip during tapping.

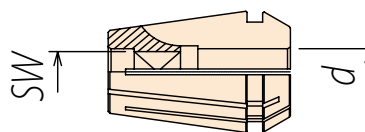
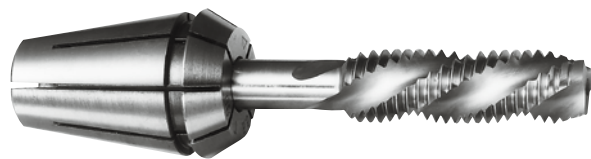

Tap Size	φ d	□ SW	(ER11-GB)	(ER16-GB)	(ER20-GB)	(ER25-GB)	(ER32-GB)
			MRC7	MRC10	MRC13	MRC16	MRC20
M3 ~ M3.5	4	3.2	MRC7	MRC10	MRC13	MRC16	MRC20
M4 ~ M4.5	5	4	MRC7-M 3	MRC10-M 3	MRC13-M 3	MRC16-M 3	MRC20-M 3
M5	5.5	4.5	-	MRC10-M 4	MRC13-M 4	MRC16-M 4	MRC20-M 4
M6	6	4.5	-	MRC10-M 5	MRC13-M 5	MRC16-M 5	MRC20-M 5
M7 ~ M8	6.2	5	MRC7-M 6	MRC10-M 6	MRC13-M 6	MRC16-M 6	MRC20-M 6
M9 ~ M10	7	5.5	-	MRC10-M 8	MRC13-M 8	MRC16-M 8	MRC20-M 8
M11	8	6	-	MRC10-M10	MRC13-M10	MRC16-M10	MRC20-M10
PT1/8-28	8	6	-	MRC10-M11	MRC13-M11	MRC16-M11	MRC20-M11
M12	8.5	6.5	-	MRC10-PT1/8	MRC13-PT1/8	MRC16-PT1/8	MRC20-PT1/8
M14 ~ M15	10.5	8	-	MRC10-M12	MRC13-M12	MRC16-M12	MRC20-M12
PT1/4-19	11	9	-	-	MRC13-M14	MRC16-M14	MRC20-M14
M16	12.5	10	-	-	MRC13-PT1/4	MRC16-PT1/4	MRC20-PT1/4
M18	14	11	-	-	-	MRC16-M16	MRC20-M16
PT3/8-19	14	11	-	-	-	MRC16-M18	MRC20-M18
M20	15	12	-	-	-	MRC16-M18	MRC20-M18
M22	17	13	-	-	-	MRC16-M20	MRC20-M20
PT1/2-14	18	14	-	-	-	-	MRC20-M22
M26 ~ M27	20	15	-	-	-	-	MRC20-PT1/2
			-	-	-	-	MRC20-M27

※ PT と PF シャンク同じ

OSGシンクロタップ用

Tap Size	φ d	□ SW	(ER11-GB)	(ER16-GB)	(ER20-GB)	(ER25-GB)	(ER32-GB)
			MRC7	MRC10	MRC13	MRC16	MRC20
M3	4	3.2	MRC7	MRC10	MRC13	MRC16	MRC20
M4 ~ M6	6	4.5	MRC7-M 3	MRC10-M 3	MRC13-M 3	MRC16-M 3	MRC20-M 3
M8 ~ M10	8	6	MRC7-M 6	MRC10-M 6	MRC13-M 6	MRC16-M 6	MRC20-M 6
M12	10	8	-	MRC10-M11	MRC13-M11	MRC16-M11	MRC20-M11
M14	12	9	-	MRC10-M φ 10	MRC13-M φ 10	MRC16-M φ 10	MRC20-M φ 10
M16	16	12	-	MRC10-M φ 12	MRC13-M φ 12	MRC16-M φ 12	MRC20-M φ 12
			-	-	-	-	MRC20-M φ 16

超高速回転用 Mini ナット

MINI NUT FOR HIGH SPEED



CODE	適用するホルダ Holder Size
ER-8MS	MRC5
ER-11MS	MRC7

小径コレットチャック用 レンチ

WRENCH FOR SMALL SIZE COLLET CHUCK

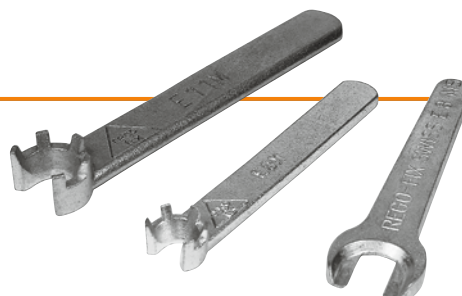

CODE	高速 Mini ナット用 Mini Nut Size	適合するホルダ Holder Size
E8M	E8MS	MRC5
E11M	E11MS	MRC7